



Model Number

V1-W-E8-BK20M-PUR-U-V1-G

Double-ended cordset, M12 to M12, LED, 4-pin, PUR cable

Features

- Built-in LED, as operating and function indicator
- UL Recognized Component
- Knurled nut suitable for tool assembly
- Flame resistant cable
- Immunity to vibration, with mechanical latching
- Gold plated contacts
- Degree of protection IP67 / IP68 / IP69K
- Suitable for drag chains

Dimensions

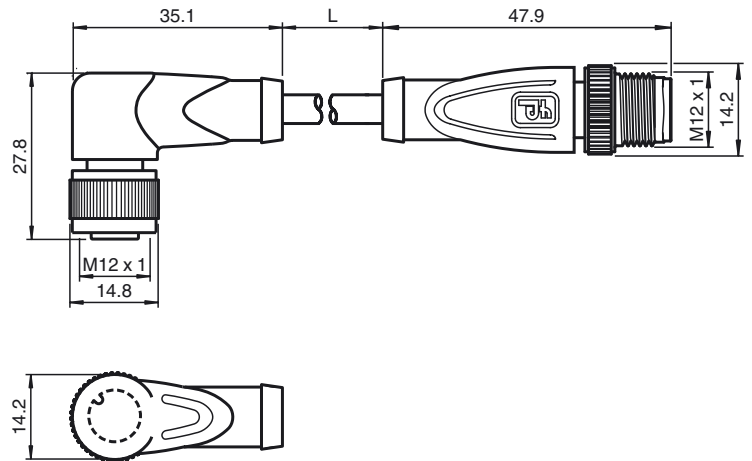

Technical data

General specifications

Number of pins	4
UL File Number	E231213

Indicators/operating means

LED green	Operating display
LED yellow	Functional display Normally closed/normally open pin 4
LED red	Functional display Normally closed/normally open pin 2

Electrical specifications

Operating voltage	U_B	max. 24 V DC \pm 15%
Operating current	I_B	max. 4 A
Volume resistance		< 5 m Ω

Ambient conditions

Ambient temperature	Body: -40 ... 90 °C (-40 ... 194 °F) cable, fixed: -40 ... 80 °C (-40 ... 176 °F) cable, flexing: -20 ... 80 °C (-4 ... 176 °F)
Pollution Degree	3

Mechanical specifications

Contact elements	spring-loaded contact socket
Pin diameter	1 mm
Degree of protection	IP67 / IP68 / IP69k
Material	
Contacts	CuSn / Au
Contact surface	Au
Body	TPU, transparent/black
Cable	PUR
Slotted nut	Diecast zinc
Sleeve connector	Diecast zinc
Core insulation	PP
Cable	extra-fine wire, flexible
Sheath diameter	\varnothing 4.3 mm
Bending radius	> 10 x cable diameter, moving > 5 x cable diameter, fixed
Color	black
Cores	4 x 0.34 mm ²
Conductor construction	42 x 0.1 mm \varnothing
Length	L 20 m
Drag chain suitability	
Drag chain cycles	\geq 5000000
Motion velocity	\leq 3.3 m/s
Torsional stress	\pm 180 °/m
Flammability	
Contact material	HB
Housing	V-2
Cable	FT2

Electrical connection

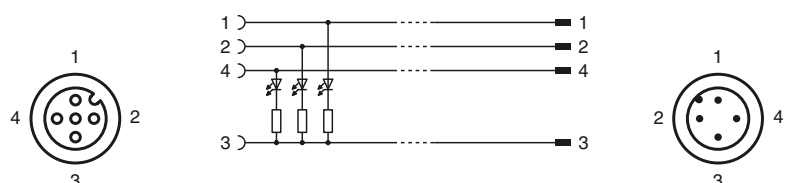

Release date: 2015-06-12 12:02 Date of issue: 2015-06-24 240784-0015_eng.xml

Compliance with standards and directives

Standard conformity

Degree of protection	EN 60529:2000
Standards	IEC 61076-2-101:2008
Flammability	Grip: UL 94
Halogen-free	IEC 60754-1:1994

Approvals and certificates

UL approval	cURus AWM 20549 AWM I/II A/B 80°C 300V FT2 (cable)
Maximum permissible operating voltage	≤ 30 V
Maximum permissible ambient temperature	≤ 80 °C (≤ 176 °F)

Release date: 2015-06-12 12:02 Date of issue: 2015-06-24 240784-0015_eng.xml